

WDM

Super
Conductive
MRI

STRIVING FOR CHANGE

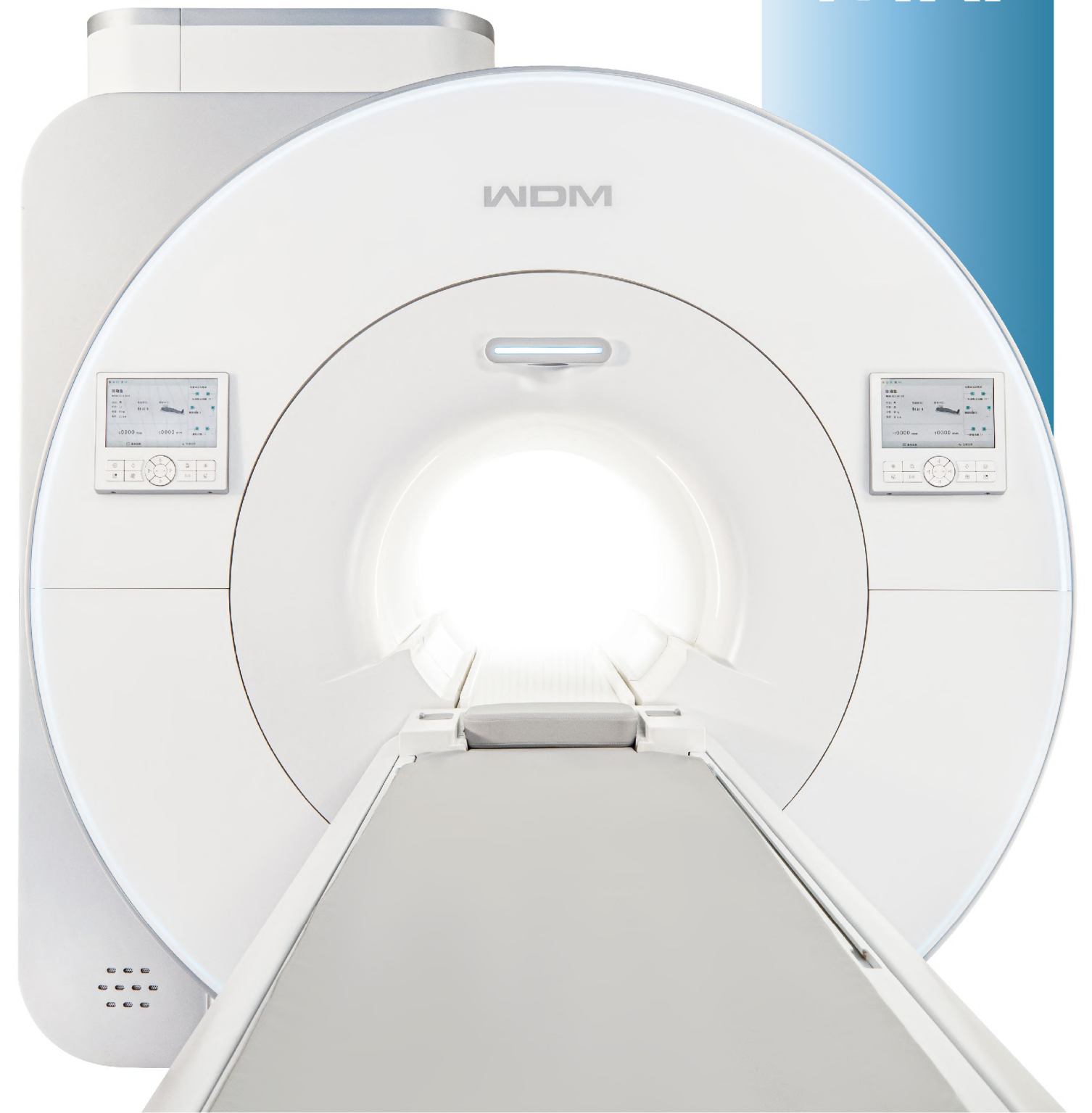

WDM

Beijing Wandong Medical Technology Co., Ltd.

Address: Building 3 No.9 Jiuxianqiaodong Road, Chaoyang

District, 100015, Beijing, P.R. China

Tel: +86-10-84575792/3/5/6

Fax: +86-10-84575794

Web: www.wandong.com.cn

E-mail: International@wandong.com.cn

Note: Design and specification subject to change without notice.

LARGE-APERTURE

i_Field 1.5T Superconductive MRI System



Superconductive magnet with short cavity of 150 cm and 71 cm bore diameter

1



175 mT/m/ms slew rate gradient system

2



24 channel RF system

3



Digital optical fiber transmission

4

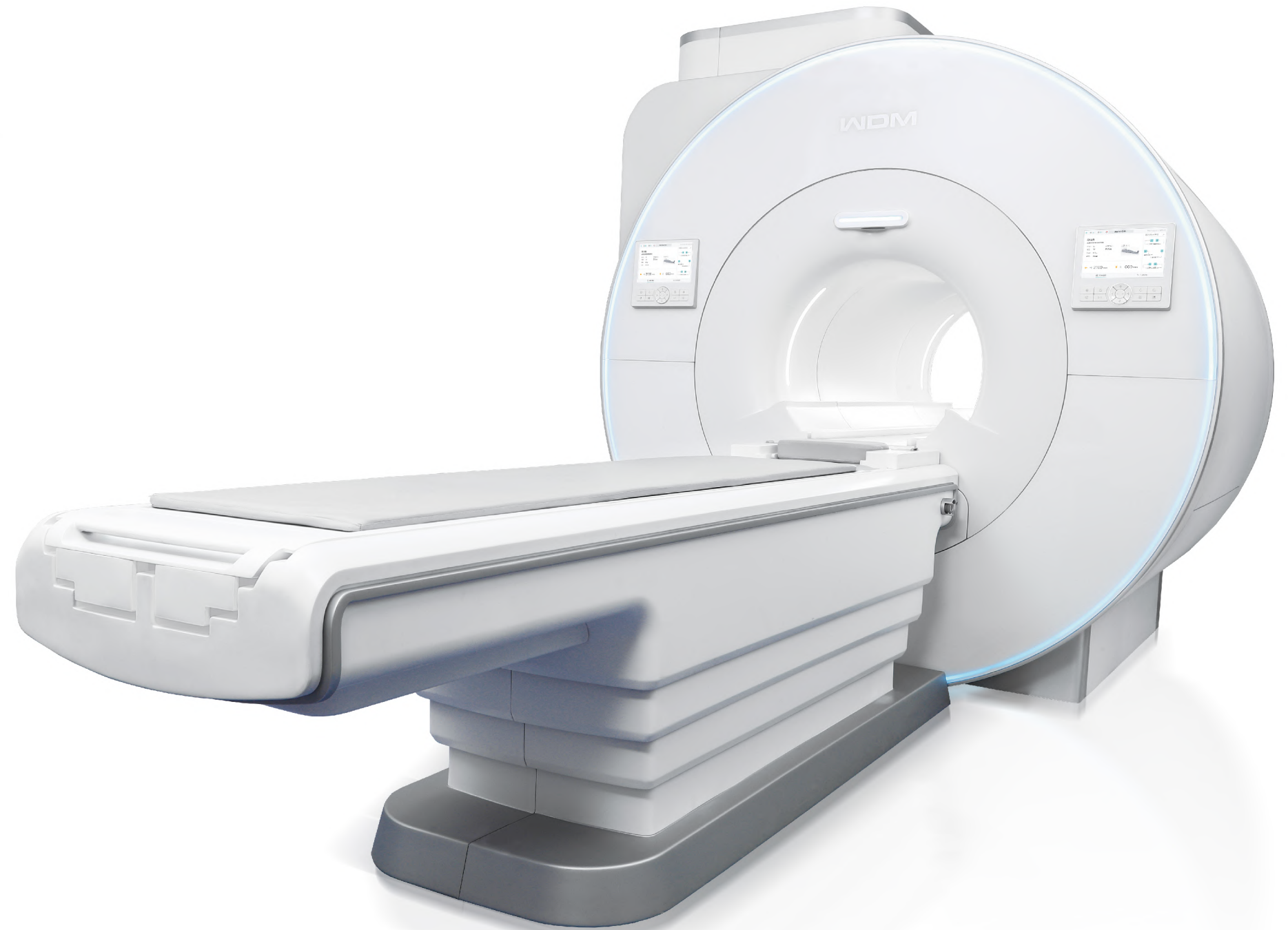
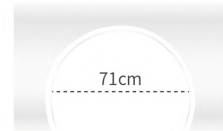
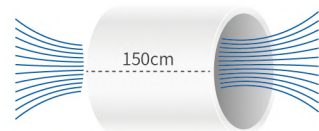

LARGE-APERTURE

i_Field 1.5T Superconductive MRI System

71cm large aperture, to provide more people with a comfortable examination experience

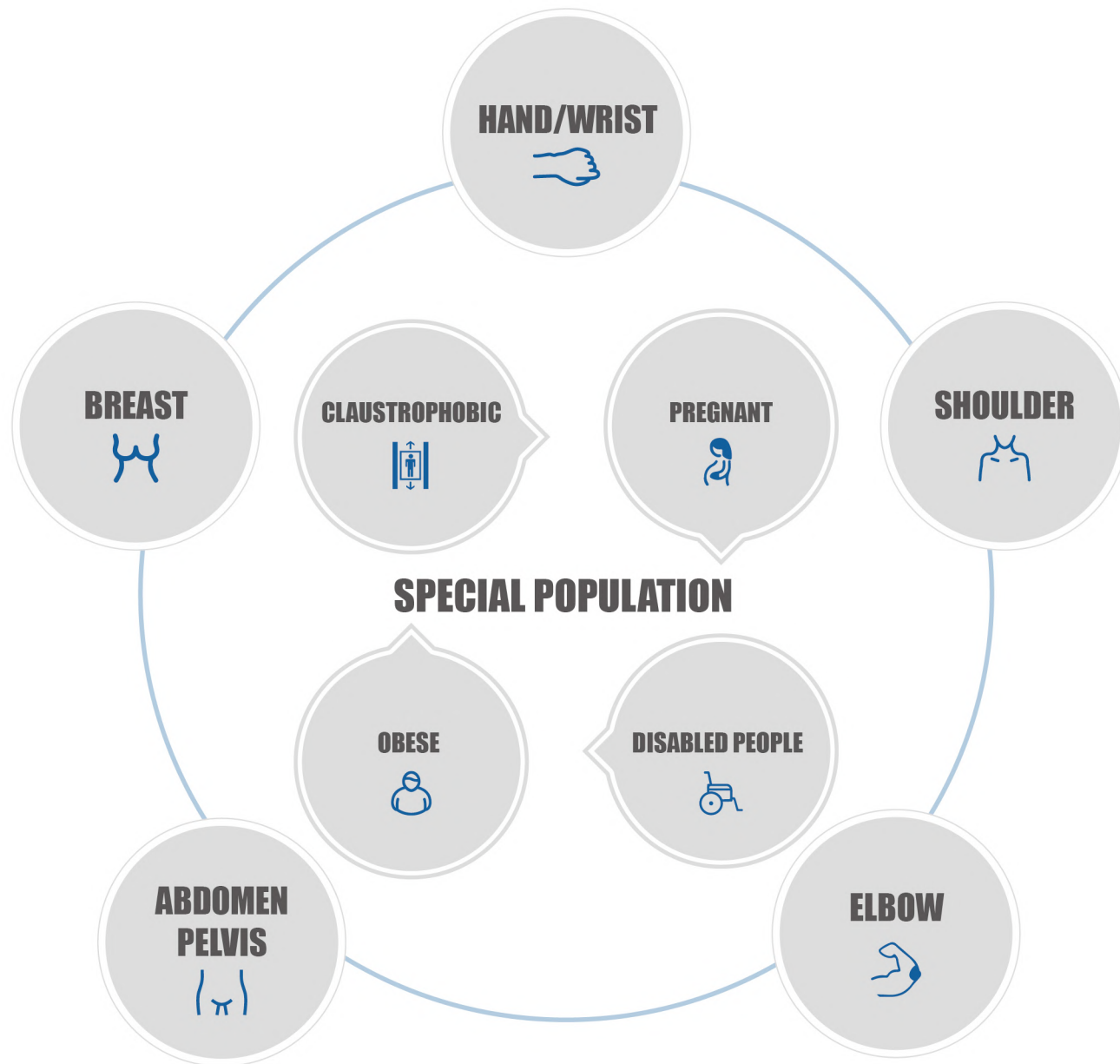

The magnetic resonance with large aperture, while balancing homogeneity and imaging quality, improves the effective imaging field, not only comprehensively serving patient who needs special care, but also ensuring excellent imaging of large FOV and off-center scan.

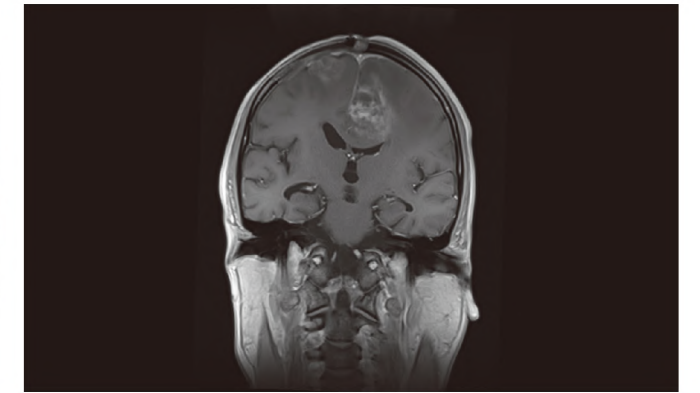

Neuro Imaging

The large aperture leaves patients more relaxed during scanning, which alleviates the feeling of space oppression for claustrophobic people reducing the use of sedation, for an examination more effective and safer.

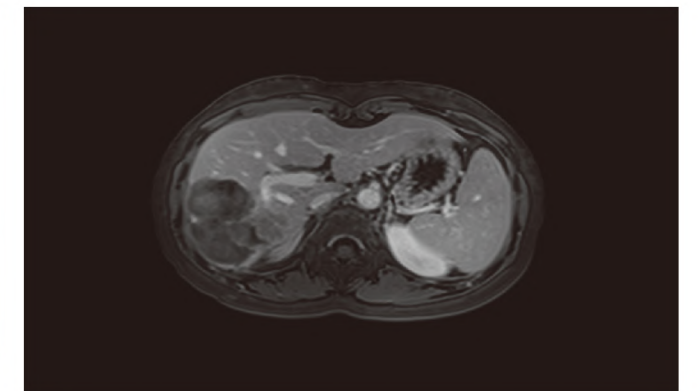

Abdomen Imaging

The large aperture of 71cm permits people lying either flat or sideways with ease by enough space, and the SAR value control scheme and uniform RF field optimization technology ensure high-quality abdominal imaging.

LARGE-APERTURE

i_Field 1.5T Superconductive MRI System

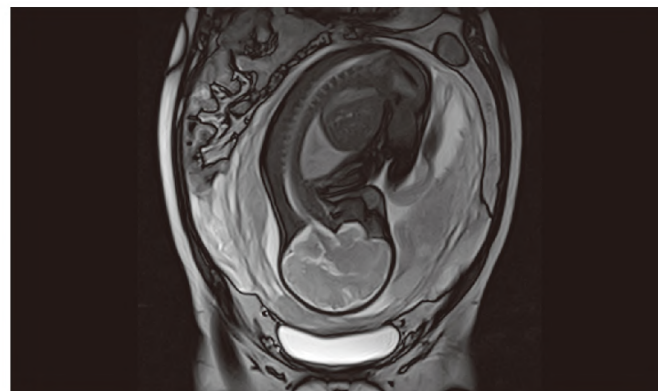

Pelvis Imaging

The examination space is enlarged so that women in the middle and late stages of pregnancy can achieve fast and accurate fetal imaging in a comfortable position and in a calm mood, without putting stress on their cardiopulmonary function.

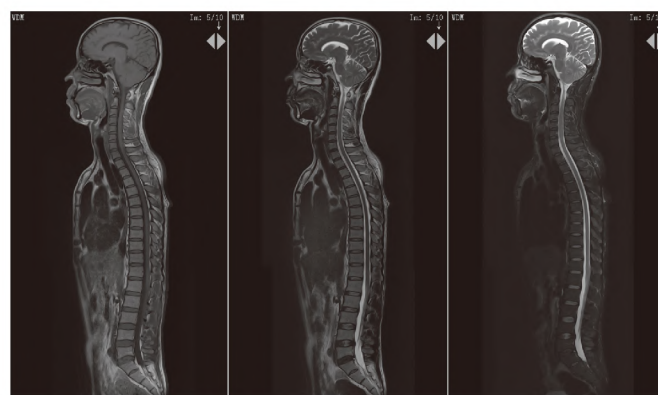

Spinal Imaging

For patients with spinal disorders who cannot lie flat, the large 71 cm aperture can accommodate the patient in a curled-up side-lying position to complete the examination smoothly with high-quality spinal imaging.

71cm

large aperture, to provide more people with a comfortable examination experience

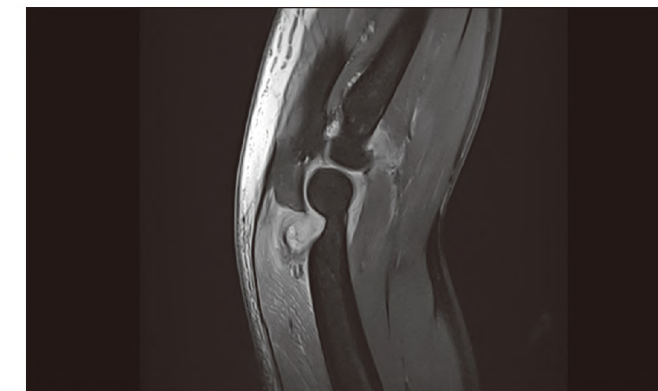

Musculoskeletal Imaging

In case of wrist, shoulder or elbow examination, the patient is able to place the examined part on the side of the body in flat-lying or side-lying position, and the wide space allows those off-center body parts to be placed closer to the center of the magnet so that to acquire better image.

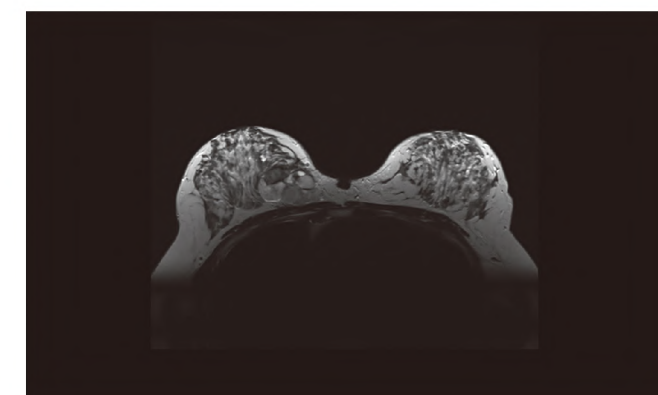

Mammo Imaging

The breast coil has a certain thickness that occupies the scanning space. In comparison with the traditional one, a larger aperture provides sufficient space to accommodate the breast coil. At the same time, the patient can have a more comfortable and natural posture and take the examination calmly.

iSPACE 1.5T

i_Space 1.5T Superconductive MRI System

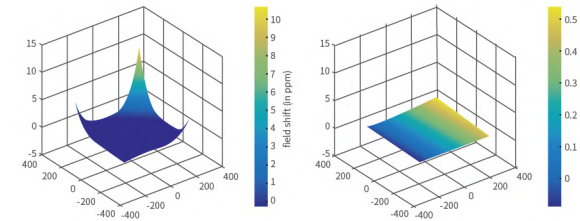

Subsecond Intelligent Shimming Technology

Complete fast and precise shimming of any part and any area in 1 second increase the homogeneity of the magnetic field to a maximum of 0.002ppm. During the entire shimming process extremely fast, it is almost unaffected by motion.

High Homogeneity Magnetic Field

Adopt the advanced magnet system, combined with intelligent shimming technology to achieve high homogeneity.

- Bringing large FOV, off-center quality images.
- Ensures a wide range of fat saturation imaging, shortens the FS sequence scan time and improves image quality.

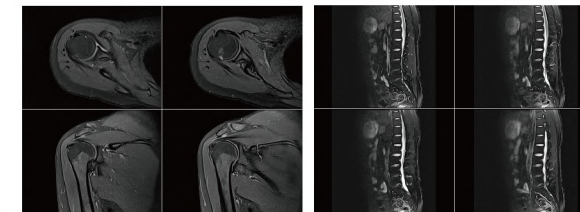

Intelligent Real-time Dynamic B₀ Eddy Current Compensation Technology

The innovative real-time compensation based on the state of eddy current improves fat saturation, reduces DWI image artifacts, and improves the image quality of B₀ eddy current sensitive sequences such as SWI.



iSPACE 1.5T

i_Space 1.5T Superconductive MRI System



Digital Optical Fiber Transmission

Completely digitalized acquisition system, gradient system and RF system are adopted to optical fiber transmission, which effectively reduce signal attenuation and keep the system isolated from external electromagnetic signal interference, ensuring efficient and stable transmission and improved image quality.

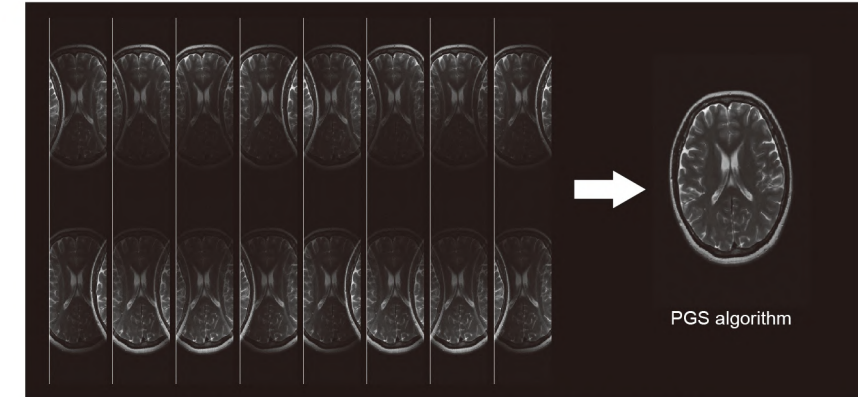

Combine and improve Pocs+Grappa+Sense acceleration technology

Intelligent Parallel Acceleration Technology

Using acceleration technology, the original images of each channel are superimposed and enhanced by PGS algorithm to produce clear, complete and uniform clinical images.

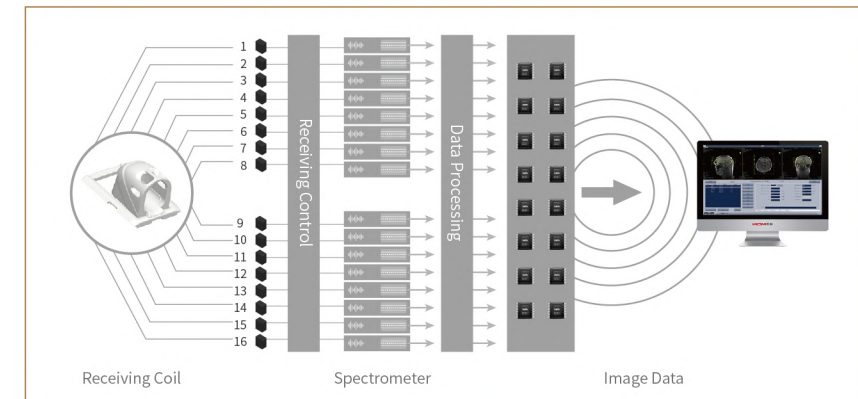

16/24/32 Channel RF Platform

The products of i_Field 1.5T and i_Space 1.5T series adopts spectrometer of 16/24/32 channel with independently corresponding coils to achieve 1:1 channel transmission from system to coil, and to achieve fast scanning of all parts of the body combining with Power sense fast imaging technology. Through reasonable coil design, more channels are used for each part.

Comprehensive Coil Solutions

Highly integrated with the magnetic resonance system, the integrated coils can perform high-quality and wide range combined imaging. When conducting multi position inspection, there is no need to change the coil one by one and move the patient repeatedly, which shortens scanning and improves the efficiency.



Wide range combined imaging



Free coil combination



No patient re-positioning



Reduced examination time

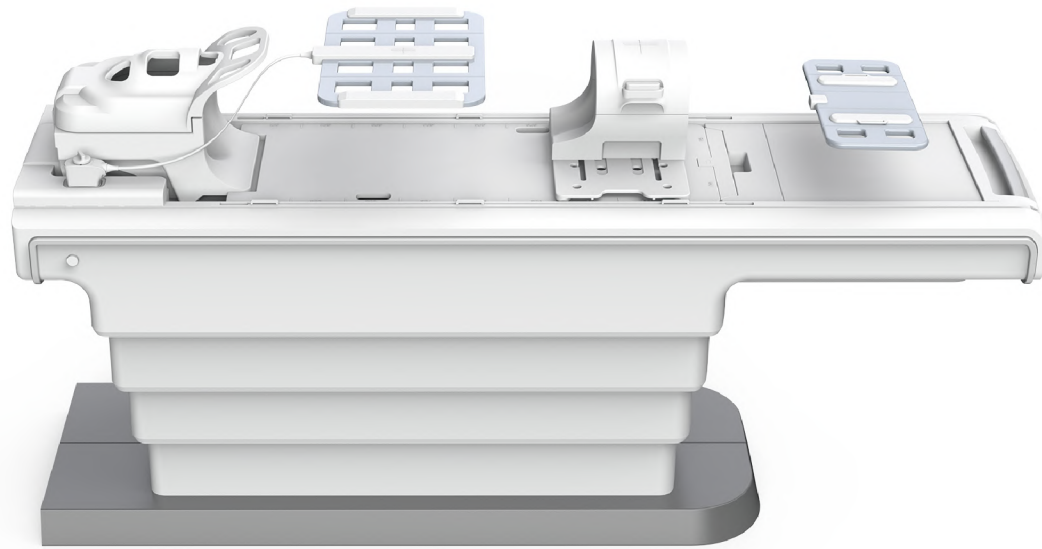

Integrated Coils



Head-Neck Combined Coil



Flexible Abdomen Coil

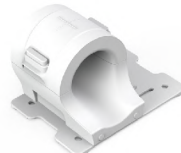

Knee Coil



Flexible Multi-function Coil



Embedded Flat Coil

Intelligent Magnet Protection System

Remote intelligent monitoring system can monitor the state of core components in real time, give early warning in case of abnormality, and reduce the system failure rate.



Reliable Service

- Active service for maximum system uptime.
- Professional installation service, qualified engineer team to guide you from floor plan design to operational training.
- Quick response, remote system diagnosis and service.
- Long-term spare parts supply.
- Sustainable hardware and software upgrade.

Clinical Images

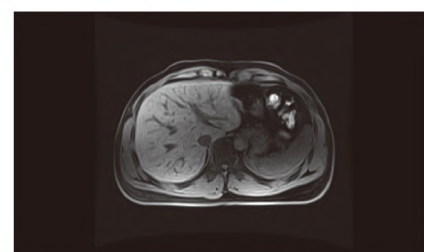

Abdominal Dynamic Enhancement (Masking)

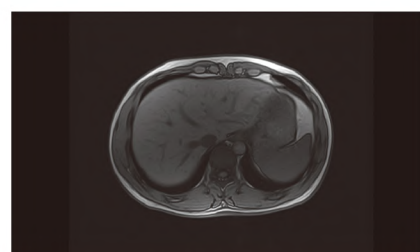

Abdominal Out-phase

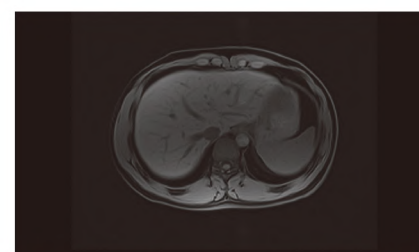

Abdominal Dixon (Water image)

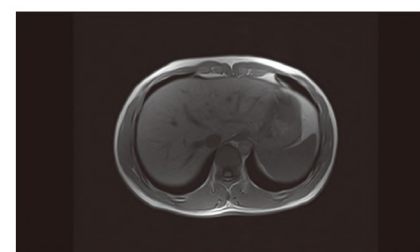

Abdominal In-phase

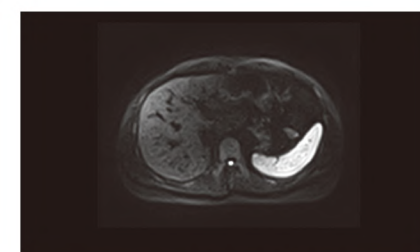

Abdominal DWI (B=800)



Abdominal MRCP

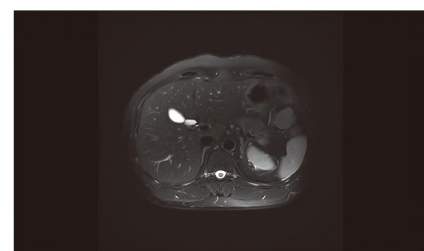

Abdominal T2 Fat Saturation

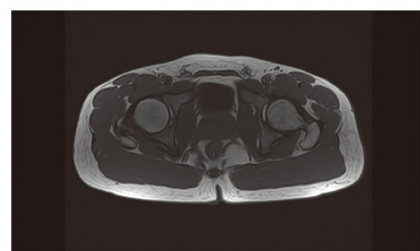

Hip Joint T1

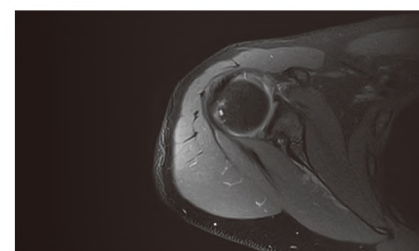

Shoulder PD Fat Saturation

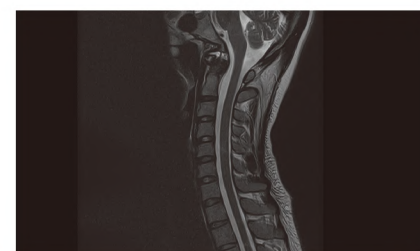

Cervical Spine T2



Cervical Spine T2 Fat Suppression (DIXON)

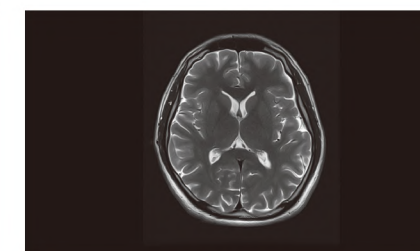

Brain T2

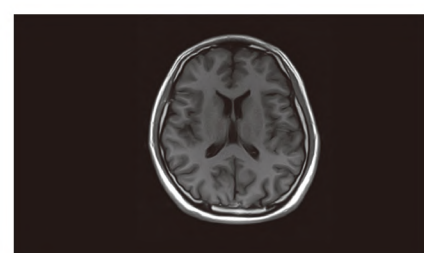

Brain T1 FLAIR

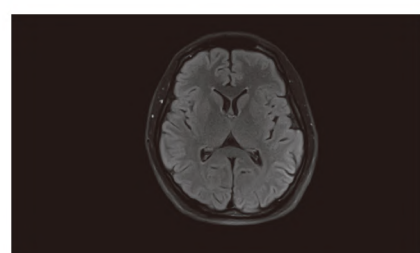

Brain T2 FLAIR

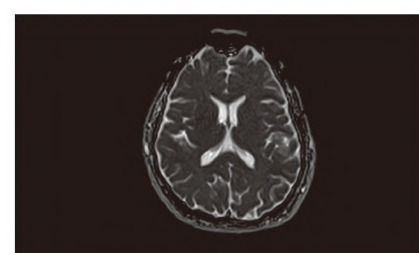

Brain ADC

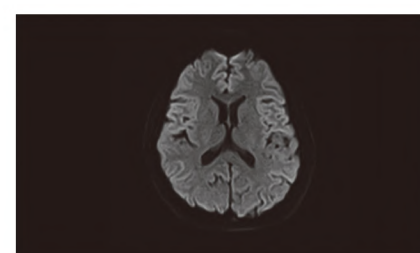

Brain DWI (B=1000)



Brain MRA

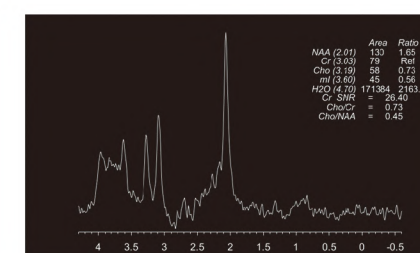

Brain MRS

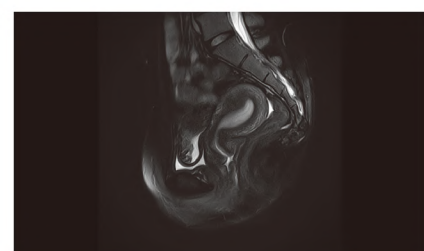

Pelvic T2 Fat Saturation

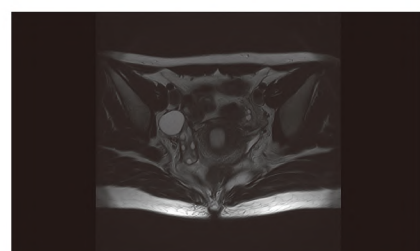

Pelvic Axial T2

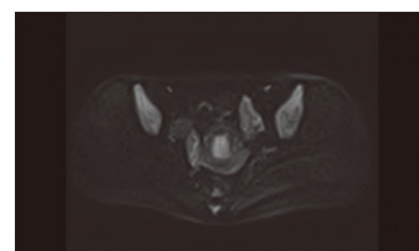

Pelvic DWI (B=1000)

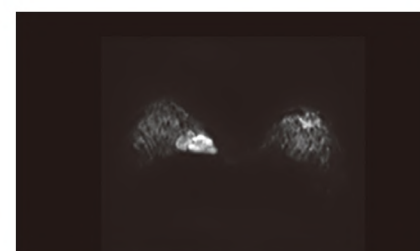

Breast DWI (B=1000)

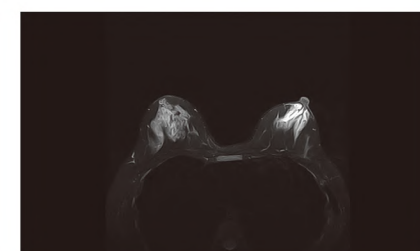

Breast T2 Fat Suppression (DIXON)

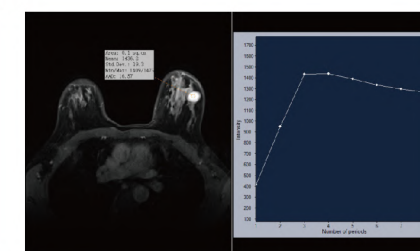

Breast Dynamic Enhancement



Ankle T1

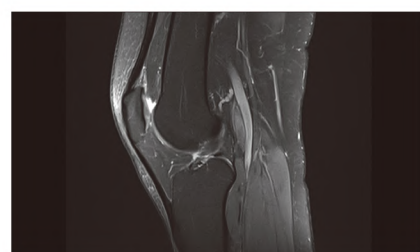

Knee PD Fat Saturation



Knee T1



Lumbar T2 (DIXON)



Lumbar T2 Fat Suppression (DIXON)

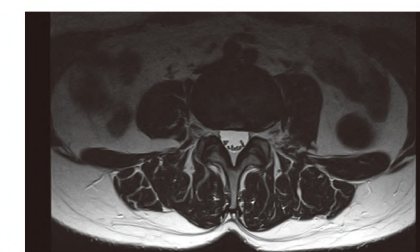

Lumbar Axial T2